



LEUPOLD

RIFLESCOPE OWNERS MANUAL

Complete Installation & Operations Instructions

Contents

Know Your Scope	4
How to Sight-In	7
Making Precise Windage and Elevation Adjustments	9
What You Should Know About Variable Power Scopes	15
Using the Illumination	20
Changing the Battery	24
Leupold Means Minimal Maintenance.....	25

Leupold Product Service	27
The Best Consumer Protection in the Business.....	30

You're Part of the Tradition

In a sport rich in tradition, Leupold® has earned its place as one of the classic names in hunting and shooting. To be sure, the Gold Ring™ scope you now own is the finest example of Leupold heritage.

Frederick Leupold came to Portland, Oregon, from Germany in 1907, and quickly established a firm to manufacture and repair surveying transits. Fred's son, Marcus, broadened the company's focus in the late 1930s after the avid outdoorsman missed a buck on the soggy western slopes of Oregon's Cascades Range. (His scope had fogged, as was common for scopes of that era.)

Frustrated by the experience, Marcus set out to build a better scope. The rest, as they say, is history.

Marcus Leupold's quest for quality has continued on to the present. In the words of the firm's founder, Frederick Leupold, "We solemnly promise never to let down on quality; the customer is entitled to a square deal." This is why we build every Leupold Gold Ring product to be worthy of the Leupold Gold Ring Full Lifetime Guarantee. It's the best customer protection in the business, and it's the best way we know to thank you for buying Leupold.

Know Your Scope

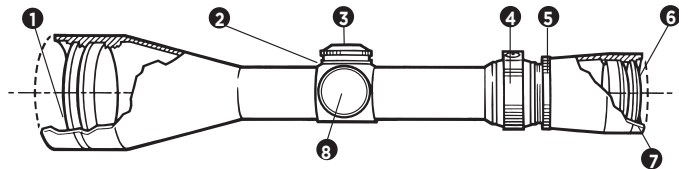

4

— CAUTION —

Always check and be certain that the firearm is unloaded before undertaking any work upon it.

1 Objective Lens

2 Windage Adjustment
(opposite side of scope)

3 Elevation Adjustment

4 Power Selector Ring

5 Eyepiece Lock Ring

6 Ocular Lens

7 Eyepiece

8 Side Parallax Adjustment

INSTALLING THE BASE, RINGS, AND SCOPE

Please refer to the instructions included with the base and rings for their proper installation on the firearm.

ESTABLISHING EYE RELIEF

Because of the safety considerations associated with proper eye relief, Leupold strongly recommends that you mount your scope as far forward as possible.

Beyond that, follow these steps:

1. With the scope as far forward in the mounts as possible, hold the rifle in your normal shooting position.
(Variable power scopes should be set at the highest magnification for this process.)

2. Slowly move the scope to the rear just until you can see a full field-of-view.
3. Position your scope here for maximum eye relief.

COMPLETING THE INSTALLATION

1. Without disturbing the optimal eye relief position, rotate the scope until the elevation adjustment dial is at the top of the scope.
2. From a firing position, check to be sure that the vertical hair of the reticle aligns with the vertical axis of the firearm.
3. Tighten the ring screws evenly and securely.

FOCUSING THE RETICLE

Secure the scope and firearm in a firm rest. Safely point the scope at a light colored background.

6

1. If the eyepiece has a lockring, grasp the eyepiece with your hand and rotate counterclockwise until the lock is loose.
2. Look through the scope while pointed at a light colored background. Look away every so often to relax your eye between focus checks. Rotate the eyepiece and recheck focus repeatedly until the reticle is sharp.
3. If your eyepiece has a lockring, retighten the lockring against the eyepiece.

How to Sight-In

SIGHTING IN

(If you are using an adjustable objective or side focus model scope, perform any correction for parallax before continuing, as explained in "Understanding Parallax" on pages 16-19.)

Begin by bore-sighting your firearm. Then head to the range for final sight-in on a target. To ensure reliable results, always fire from a rested position when performing these steps.

NOTE: *Bore-sighting alone is not sufficient to sight-in a scope. You must make final adjustments by shooting the firearm using the same ammunition you use in the field.*

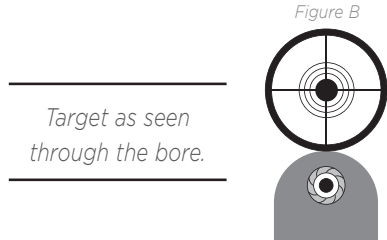
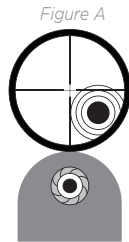

1. Fire a shot or two.
2. If you are several inches off center, make an appropriate amount of adjustment to move the reticle to the center of the target.
3. Carefully fire a three-shot group.
4. Use the center of that group as a reference point for the final adjustments to windage and elevation.

8

On the sample target, the center of the group is two inches low and three inches right. Assuming you're sighting-in at 100 yards, you should make a 2-MOA adjustment up, and a 3-MOA adjustment left. Your next three-shot group should be very close to the center of the target. To learn about making final adjustments, proceed to the upcoming section on windage and elevation adjustments.

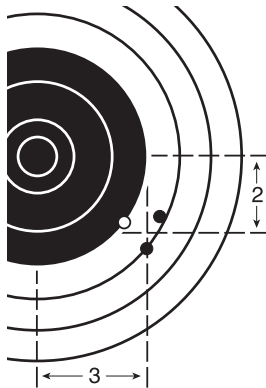

Making Precise Windage And Elevation Adjustments

The style of elevation and windage adjustments on Leupold riflescopes vary with specific models. Each, however, is clearly marked in easy to read increments. If, for example, there are four hash marks from zero to (and including) the number one on an adjustment dial, then the value of each increment of adjustment on that dial is 1/4-MOA. It is the same with all Leupold adjustment dials. 1-MOA moves the point of impact at 100 yards by 1 inch. At 100 meters, it moves 29mm.

The letters found on the windage and elevation dials refer to the direction that the point-of-impact of the bullet is moved when an adjustment is made.

ADJUSTING WINDAGE AND ELEVATION ON CDS TARGET AND TACTICAL SCOPES

Select Leupold CDS Target, Competition and Tactical scopes have micrometer-target style windage and elevation adjustments. A click for each adjustment division can be both heard and felt so adjustments to the scope can be made without looking at the dials. Indicators on the micrometer portion of the dial show the number of complete 360° rotations that have been made.

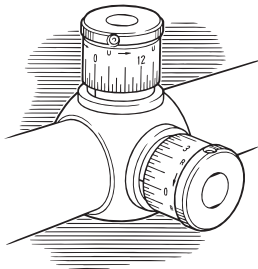

CUSTOM DIAL SYSTEM™

Leupold CDS® dials move point of impact ¼ MOA or 1cm per click, based on model, but the custom dial is marked in distances that are keyed to your particular load. If you need to take a shot at 350 yards, you simply dial the elevation adjustment to 3.5 (the yardage, ÷100), the elevation correction is now complete. If a wind hold is required, please refer to the Custom Wind Chart that was included with the custom dial. If your Leupold riflescope is a model with CDS ZeroLock™ adjustment dial, you must push inward on the lock release button located on the outer edge of the dial above the zero indicator mark to make an adjustment. Once the dial has

been turned one or more clicks past the zero position it is no longer necessary to press the lock release button. The CDS ZeroLock adjustment dial will only lock when at the zero position of the dial.

ZEROING THE WINDAGE AND ELEVATION DIALS AFTER SIGHTING IN

All Leupold scopes feature adjustment dials that can be repositioned to align the marked zero of the dial with the position indicator. This allows the shooter to know the original zero of the rifle in the event that further adjustments are made in the field.

Most Leupold scope models have an indicator ring that can be moved independently to align with the zero on the adjustment dial. To reposition the indicator ring simply rotate it until the position indicator notch/pointer is aligned with the zero of the adjustment dial.

12

To reposition the finger-click dials on VX-6 models, simply grasp the dial firmly around the edges and pull straight up until you hear an audible click. Rotate the dial until the zero on the dial is aligned with the witness mark on the maintube. To lock the dial into position, push down until you hear an audible click.

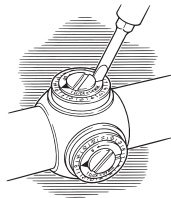

Slotted adjustments

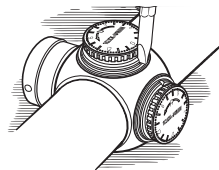

Finger-click adjustments



VX-6 adjustments

To reposition the dials and the zero stop on VX-6 Target adjustments:

1. Loosen the set screws on top of the dial until it moves freely.
2. Rotate the dial until the -0- on the indicator ring/zero stop aligns with the bottom of the dial.
3. Tighten the set screws until the dial is secure.
4. Each number on the indicator ring equals one complete revolution of the adjustment dial.

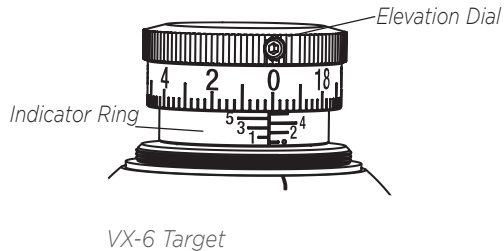

To reposition the dials on CDS, CDS-ZL, or CDS Target and Tactical models:

1. Loosen the set screws that surround the top of the dial until the cylinder turns freely.
2. Turn the cylinder dial by hand to align the zero with the witness mark at the base of the dial. For CDS-ZL, push inward on the lock release button to turn the dial.
3. Tighten the set screws until the dial is secure.

14

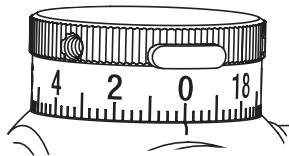

VX-6 CDS-ZL

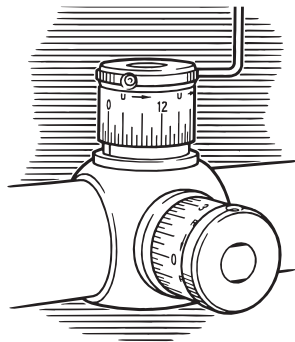

CDS Target and Tactical

What You Should Know About Variable Power Scopes

Leupold variable power scopes allow you to select from a range of magnifications to suit your particular rifle, cartridge, and shooting needs.

WARNING: Do not loosen the screw in the power selector ring. Doing so will release the internal gas that keeps the scope fog free. Loosening the screw will also disconnect a pin that controls the internal operations, causing other problems that would require factory repairs. Do not lubricate the power selector ring; doing so is unnecessary.

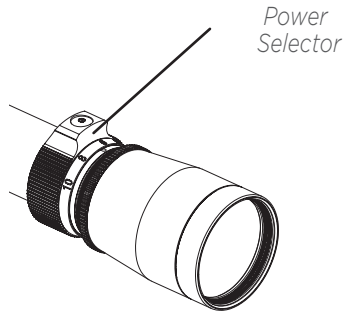

UNDERSTANDING PARALLAX

Parallax is the apparent movement of the target relative to the reticle when you move your eye away from the center point of the eyepiece. It occurs when the image of the target does not fall on the same optical plane as the reticle. This can cause a small shift in the point of aim.

16

Maximum parallax occurs when your eye is at the very edge of the exit pupil. At short distances, the parallax effect does not affect accuracy. It is also good to remember that, as long as you are sighting straight through the middle of the scope, or close to it, parallax will have virtually no effect on accuracy in a hunting situation.

ABOUT FIXED PARALLAX DISTANCE SCOPES

Any fixed focus optical system can be adjusted to be parallax free at only one distance. Most Leupold scopes are adjusted at the factory to be parallax free at 150 yards. However, there are exceptions:

1. Leupold rimfire scopes are set to be parallax free at 60 yards.
2. Leupold Shotgun/Muzzleloader scopes are set to be parallax free at 75 yards. UltimateSlam LR models are parallax free at 150 yards.
3. Leupold Handgun and Ultralight 2.5x scopes are set to be parallax free at 100 yards.

THE ADVANTAGE OF ADJUSTABLE PARALLAX SETTING SCOPES

Target shooting and varmint hunting demand extreme accuracy. You must have a scope with a parallax adjustment dial for precise shooting at various ranges. The parallax adjustment can be located either at the objective end of the scope or on the side of the adjustment turret housing. To eliminate parallax in side focus or adjustable objective scopes, follow these steps:

1. The reticle should be clear (focused) before adjusting the parallax. If it is not, follow the instructions under “Focusing the Reticle.” See page 6.

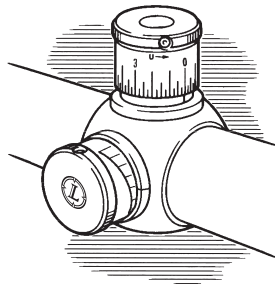

Side Focus Adjustment

2. With the firearm in a stable position, look through the scope, concentrating on the center aiming point of the reticle.
3. Move your head slightly up and down while turning the side parallax or adjustable objective ring until the reticle does not move in relation to the target.

18

NOTE: Settings may vary slightly per individual preferences, air temperature, and atmospheric conditions.

NOTE: The side focus adjustment knob is not to be used to focus the target image. If the reticle is first focused and the parallax then properly set, the image should be clear.

EFR SCOPES AND THE ADJUSTABLE OBJECTIVE

Leupold EFR (Extended Focus Range) scopes can eliminate parallax for distances as short as 10 meters. Unlike conventional adjustable objective scopes, the focus ring on EFR models rotates more than 360°. It is important to pay special attention when adjusting these scopes.

1. Turn the focus ring counterclockwise (when viewing through the eyepiece) until it stops.
2. Turn the focus ring clockwise until the “10m” mark aligns with the indicator mark on the bell of the scope.
3. From this point, all readings of the focus ring are in numerical order when the ring is turned clockwise from the shooting position.
4. Adjust the ring as you would a standard adjustable objective model.

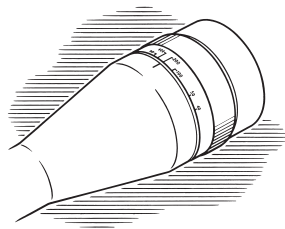

*To adjust the parallax distance,
turn the focus ring.*

Using the Illuminated Reticle

Leupold Illuminated Reticle scopes may be used in either the standard or the illuminated state. When not illuminated, the reticle performs the same as the reticle in a standard Leupold scope.

20

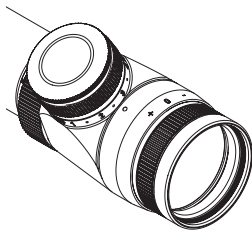

The Dial illumination control is located on the eyepiece

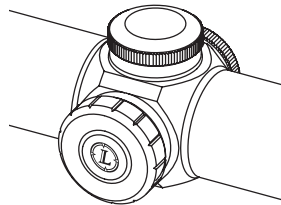

The Push Button illumination control is located on the adjustment turret

Dial Illumination Control

To illuminate the reticle:

1. Grasp the illumination dial located on top of the eyepiece.
2. Turn the dial clockwise from the OFF position until the desired illumination intensity is reached.
3. The first 4 settings are designed to be used in low light, while settings 5-8 are intended for use in brighter situations.
4. For convenience, there is an OFF position located between each of the intensity settings, allowing you to preserve the battery and quickly obtain your preferred illumination setting.

Push Button Illumination Control

To illuminate the reticle:

1. Press and release the button on the left side of the adjustment turret.
2. To adjust the intensity of the aiming dot, press and release the button repeatedly. The aiming dot will flash 5 times when the brightest setting is reached, then begin decreasing each time the button is subsequently depressed. When the lowest setting is reached, the aiming dot will flash 5 times and begin increasing each time the button is subsequently depressed.

3. To deactivate the illumination, press and hold the button for at least 3 seconds. When reactivated, the illumination will return to the last used setting.

Note - Advanced Use: To change the direction of adjustment, ie change from increasing intensity to decreasing intensity, press and hold the button for 2 seconds and immediately release the button. Then continue pressing and releasing to change intensity.

Leupold third generation illumination systems utilize a proprietary Motion Sensor Technology (MST™) to automatically preserve battery life.

If the illumination is activated and the scope/rifle is left dormant for a period of five minutes, the illumination will automatically turn off, but will immediately reactivate as soon as the scope/rifle is moved even slightly.

NOTE: VX-R and VX-6 scope models will begin a 10 sec. count down prior to the 5 minute timeout expiring. The reticle will flash 10 times before turning off.

To preserve the life of the battery, always remember to turn the illumination off when the scope is not in use. For prolonged storage, remove the battery.

WARNING: Always check to ensure that the firearm is unloaded before changing the battery in the scope.

Low Battery Indicator:

For convenience, there is a low battery indicator feature which will cause the reticle to flash upon activation. To check the status of your battery, simply turn the illumination off, then back on. If the reticle flashes, you will soon need to replace the battery.

Changing the Battery

If the reticle fails to illuminate or appears dim even on the highest illumination setting, it is necessary to change the battery.

Leupold third generation Illuminated Reticle scopes use

24

To change the battery:

1. Twist the cover counterclockwise.
2. Remove the old battery from its position in the center of the dial/button.

3. Insert the new battery, positive (+) side up.
4. Replace the battery cover on the illumination dial and turn it clockwise until it is secure.



The battery for Illuminated Reticle scopes is located inside the control dial or Push Button and can be changed without tools.

Leupold Means Minimal Maintenance

LENSES

Leupold scope lenses are coated to reduce light reflections and light scattering, thus increasing light transmission through the scope. They should be cleaned as carefully as you would a camera lens. Begin by using a lens brush to remove dust and then pure alcohol, high-grade glass cleaner, or pure water on a cotton swab.

WINDAGE / ELEVATION ADJUSTMENTS

These adjustments are permanently lubricated. There is no need to lubricate them. Keep the adjustment covers

on, except when adjusting, to keep out dust and dirt. (It's worth noting that, unlike competitive brands, Leupold scopes are waterproof even without the covers in place.)

EYEPiece ADJUSTMENT

This adjustment is permanently lubricated. There is no need to lubricate it. The eyepiece can be rotated as far as it will go in either direction. It will not detach from the scope as there is an internal lock ring.

SEALS

Leupold scopes are sealed from within by several methods, including O-rings. All seals are permanent and require no maintenance.

SCOPE EXTERIOR

26

Leupold scopes are made of rugged 6061-T6 aircraft aluminum alloy. No maintenance of any kind is required; simply wipe off any dirt or fingerprints that accumulate with a clean, dry cloth.

ADJUSTABLE OBJECTIVE/SIDE PARALLAX DIAL

No lubrication is required.

TROUBLE SHOOTING TIPS

Before you ship a scope back to the factory for service or repair, please check the following items.

1. Check the mount. Make sure the scope is mounted securely to the rifle. Try, with bare hands only, to gently twist the scope in the rings or see if anything moves when you jiggle it. If there is any movement, retighten the mounting system according to mounting instructions.
2. Make sure the action of your rifle is properly bedded in the stock, and that all receiver screws are tight and have been tightened in the sequence recommended

by the manufacturer. A loosely fitted stock can cause changes to the point-of-impact.

3. When test firing a rifle to check the point-of-impact relative to windage and elevation adjustments, be sure to fire from a solid bench with sandbags supporting the forearm and buttstock.
4. Be sure to use factory-loaded ammunition of the same bullet type, weight, and preferably, lot number. If one type of ammunition does not shoot well, try another brand or bullet weight.
5. Be certain that both the barrel and chamber are clean. Heavy factory grease or copper fouling can diminish the accuracy of the firearm.

LEUPOLD PRODUCT SERVICE

If your Leupold Gold Ring scope fails to perform in any way, you may return it directly to the factory (or one of our international service centers) for service. We recommend contacting Leupold Technical Service at 1-800-Leupold (538-7653), and following these shipping instructions:

1. Remove the rings and any other accessories from the scope.
2. Record the serial number of the scope and keep it for your records.

3. Include a note with your name, address, telephone number, E-mail address, and a description of the problem.
4. Pack the scope in its original box (if you have it), as this is the safest shipping container. Wrap the package securely using filament strapping tape on the outside.
5. Ship the scope by parcel or mail service (insured, if possible) to one of the following addresses:

28

IN THE UNITED STATES:

Parcel or Mail Service:

Leupold Product Service
14400 NW Greenbrier Parkway
Beaverton, OR 97006-5790 USA

OUTSIDE THE UNITED STATES:

Canada: Korth Group Ltd., 103 Stockton Point, Box 490
Okotoks, AB T1S 1A7, Canada

Australia: Nioa, PO Box 191,
Pinkenba, Qld 4008 Australia
(for items originating from Australia, New Zealand, New Caledonia and Japan)

Sweden: HDF Gyttorp Jakt AB, Svarvaregatan 5,
S-302 50 Halmstad, Sweden

Our Product Service telephone numbers are
Local (503) 526-1400. Toll-Free 1(800) LEUPOLD (538-7653).
Fax (503) 352-7621.

Leupold+Stevens, Inc. products, parts, components, technical data, and services are controlled for export and import, by the U.S. Department of State under the International Traffic in Arms Regulations (22 CFR, Parts 120-130) or the Department of Commerce under the Bureau of Industry and Security Export Administration Regulations, EAR (15 CFR, Parts 730-774). Diversion contrary to U.S. law prohibited.

The Best Consumer Protection in the Business

Leupold + Stevens, Inc. is an American, family owned, fifth generation company that has been designing, machining and assembling precision optical instruments for over 100 years. Leupold's success has been built on its commitment to your absolute satisfaction and its commitment to building the best optics for the shooting sports and for the law enforcement/military community. It is for these reasons that Leupold+ Stevens, Inc. offers the Leupold Full Lifetime Guarantee.

If any Leupold Gold Ring™ product is found to have defects in materials or workmanship, Leupold + Stevens, Inc. will, at its option, repair or replace it. FREE. Even if you are not the original

owner. No warranty card is required. No time limit applies. Warranty is void if damage results from unauthorized repair, alteration, or misuse.

The Leupold Guarantee in Germany and other countries where legally prohibited: Leupold is convinced of the high-quality and reliability of its Gold Ring products. This is why each U.S. customer is afforded a lifetime guarantee. For legal reasons, this guarantee must be restricted to 30 years in Germany and other countries where an unlimited lifetime guarantee is prohibited. Each owner, even those that acquired a Gold Ring product used, can make use of this 30 year guarantee.

30

LEUPOLD TACTICAL PRODUCTS WARRANTY

Warranties on Leupold Tactical optical products vary depending on use and other factors. For more information regarding the warranties on these products, contact Leupold at (503) 526-1400 or 1-800-Leupold (538-7653).

THE LEUPOLD ELECTRONIC WARRANTY

The electronics in illuminated riflescopes/sights, Leupold MX/MXc series flashlights and flashlight components are covered by the Leupold Gold Ring electronics warranty and are protected from defects in materials and workmanship for two years from the date of purchase. Certain special purpose products are covered by specific warranties in regards to their own individual features and use. Warranty is void if damage results from unauthorized repair, alteration, or misuse.

LEUPOLD MAKES MORE THAN SCOPES

See our complete line of rangefinders, mounting systems, binoculars, spotting scopes, and accessories at your nearest Leupold dealer.

For a free Leupold catalog, write to:

Leupold + Stevens, Inc., P.O. Box 688, Beaverton, OR 97075, call (503) 526-1400 or (800) LEUPOLD (538-7653), or send us an E-mail through our Web site at www.leupold.com.

The Leupold package is made in part from recycled materials and is 100% recyclable. This includes the black or white polypropylene supports, which are made of an accepted recyclable material. Many Leupold owners keep their scope boxes. If you have no use for yours, we encourage you to dispose of it responsibly.

LEUPOLD, GOLDEN RING, MARK 4, the Golden Ring design, the circle-L reticle logo design, and various other marks are registered trademarks of Leupold + Stevens, Inc. All marks, including corporate logos and emblems, are subject to Leupold's rights and may not be used in connection with any product or service that is not Leupold's, or in any manner that disparages or discredits Leupold, or in a manner likely to cause confusion.

Certain other trademarks used in connection with Leupold products and services are the property of their respective owners, and are used with permission. BOONE AND CROCKETT CLUB and BOONE AND CROCKETT are registered trademarks of the Boone and Crockett Club. RMEF and

ROCKY MOUNTAIN ELK FOUNDATION are registered trademarks of the Rocky Mountain Elk Foundation. ADVANTAGE TIMBER and ADVANTAGE TIMBER HD are trademarks or registered trademarks of Jordan Outdoor Enterprises Ltd. MOSSY OAK BREAK-UP, MOSSY OAK BRUSH, MOSSY OAK OBSESSION, and MOSSY OAK TREESTAND are trademarks or registered trademarks of HAAS Outdoors, Inc. A.R.M.S. is a registered trademark of Atlantic Research Marketing Systems, Inc.

We reserve the right to make design and/or material modifications without prior notice.

Copyright © 2015 Leupold+Stevens, Inc.
All rights reserved.

LEUPOLD+STEVENS INC.

P.O. BOX 688

BEAVERTON, OR 97075-0688 U.S.A.

1(800) LEUPOLD (538-7653)

14400 NW GREENBRIER PARKWAY

BEAVERTON, OR 97006-5790 U.S.A.

(503) 526-1400



PART #59809 ARTWORK #59458K